

## ■ パッキン土台水切

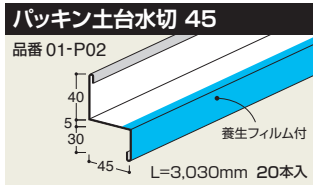

## ■ 片ハゼ水切

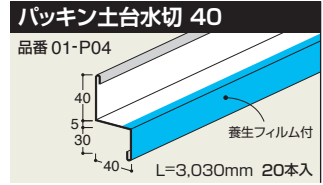
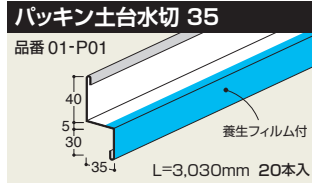
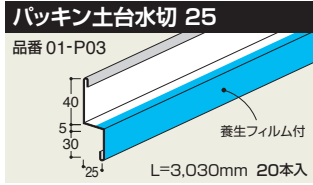
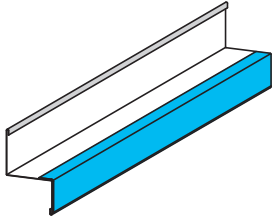
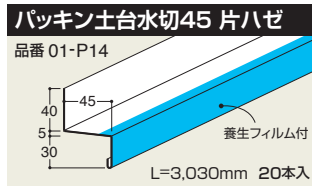
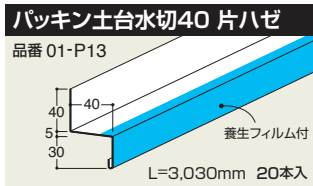
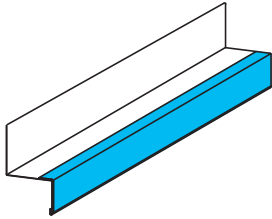

## ■ 通気水切

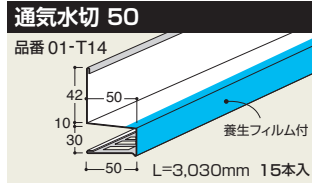
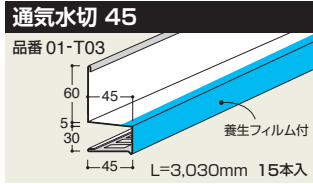
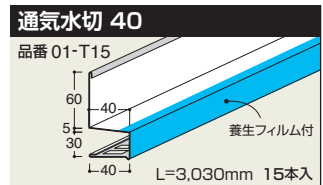
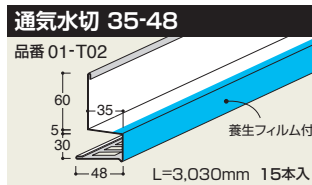
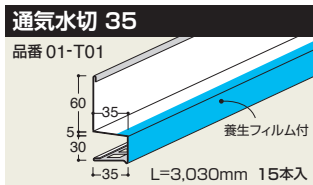
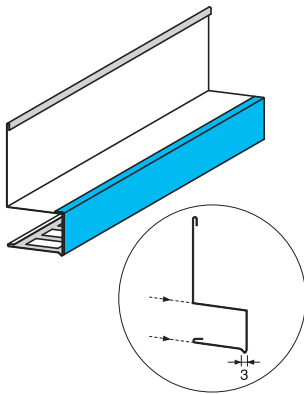

## ■ 片ハゼ水切

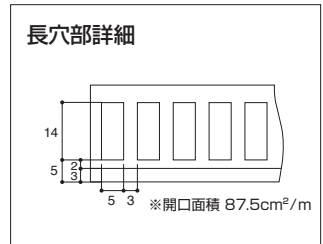
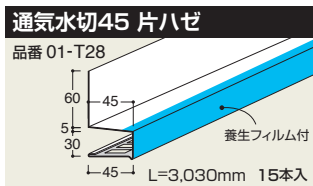
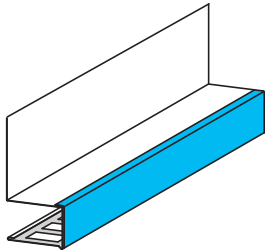

## ■ 中間水切

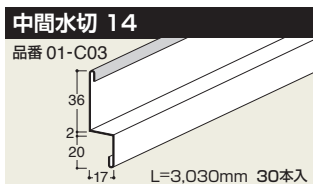

## ■ オーバーハング

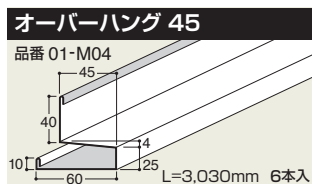
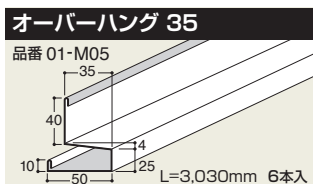
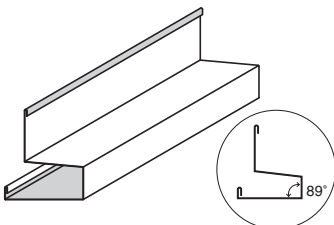

【ご注意】土台(通気)水切の養生フィルムは、施工完了後、すみやかに取りはがしてください。